

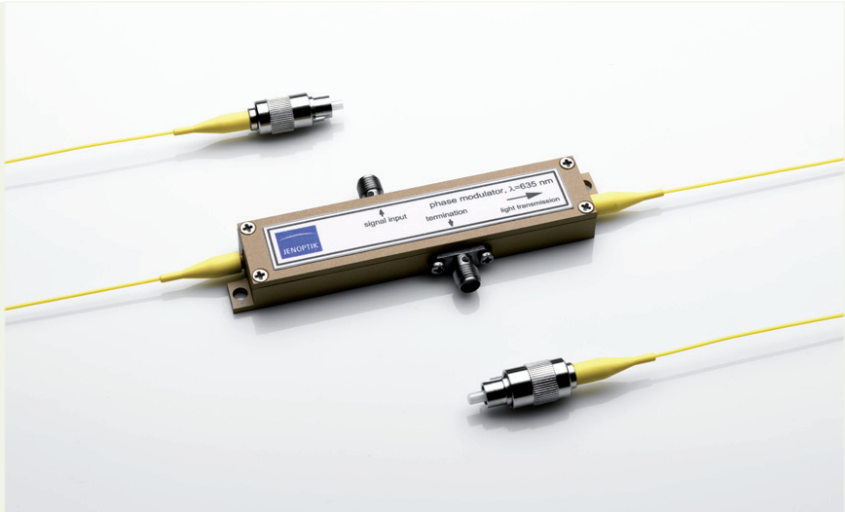

Integrated-optical modulators

Technical information and instructions for use



Content

1. Electrooptical modulators	3
1.1. Integrated-optical waveguides	3
1.2. The linear electrooptic effect	3
1.3. Phase modulators	4
1.4. Amplitude modulators	5
2. Selection Criteria	6
2.1. Wavelength and wavelength range	6
2.2. Fibre pigtail and polarisation of light	7
2.3. Optical power	8
2.4. Spectral width of light	8
3. Technical data	9
4. Electrical control of the modulators	11
4.1. Internal wiring of the modulator	11
4.2. Driving of the modulator	13
4.3. Determination of V_0 and V_π	14
4.4. DC-behaviour of lithium niobate modulators	15
5. Application examples	18
5.1. Pulse slicing	18
5.2. Pulse picking	18
6. Description of terms	21

Electrooptical modulators

Integrated-optical modulators

Technical information and instructions for use

1. Electrooptical modulators

1.1. Integrated-optical waveguides

Integrated-optical waveguides are able to guide light along a determined path analogue to optical fibre. They are fabricated on or in planar substrates and it is the properties of this substrate that determine the waveguide properties such as electrooptical modulation.

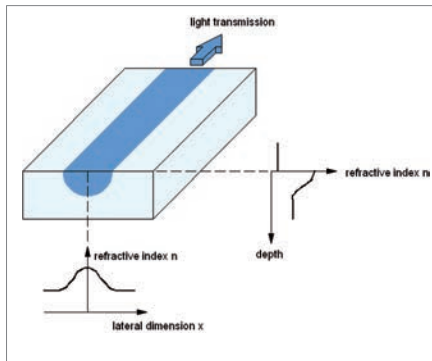

Fig. 1.1 - Scheme of an integrated-optical waveguide

The waveguide consists of a channel with higher refractive index compared to the surrounding material (Fig. 1.1). The refractive index transition at the channel walls can be steplike or smoothly like described here. The light is guided by means of total internal reflection at the channel walls. Depending on the wavelength, substrate refractive index, refractive index increase, width and depth of the channel one or more transverse oscillation states

(modes) can be excited. The single mode operation is of great interest since it is essential for the function of many integrated-optical elements.

Integrated-optical elements are usually provided with optical fibres particularly in optical communication technology. To achieve a good coupling efficiency to the fibre, single mode waveguides are typically three to nine microns in width and depth, depending on wavelength. Various elements like Y-branches, polarizers, phase- and amplitude modulators, switches or wavelength multiplexers can be implemented using integrated-optical waveguides.

1.2. The linear electrooptic effect

The linear electrooptic effect, also known as Pockels-Effect, is an optically second order non-linear effect. It describes the change of the refractive index of an optical material if an external electric field is applied. The amount of change in refractive index is proportional to the electric field strength, its direction and the polarisation of the light. This interaction is described with the electrooptic tensor and is mostly anisotropic. The effect occurs in polar materials, including ferroelectric crystals. The preferred material for the fabrication of integrated-optical modulators is Lithium niobate (LiNbO_3), which is also used for the modulators described here. In this crystal the strongest interaction occurs between the outer

Electrooptical modulators

electric field in the crystallographic z-direction (E_3) and z-polarised light with its refractive index n_3 . It amounts to:

$$\Delta n_3 = -\frac{1}{2} n_3^3 r_{33} E_3$$

The electrooptic coefficient r_{33} is 33 pm/V. The definite function requires the use of linear polarised light.

1.3. Phase modulators

If an electric field is applied to a waveguide using electrodes of the length L , the refractive index changes in the area between the electrodes which is followed by a phase shift of the guided light. Because of the very small waveguide cross section it is not possible to place electrodes to produce a homogeneous electric field. Therefore a coplanar electrode arrangement on the crystal surface is preferred (Fig. 1.2).

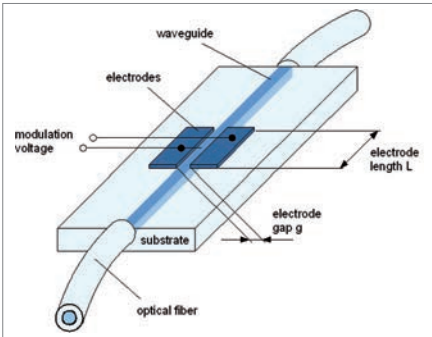

Fig. 1.2 - Phase modulator

This generates an inhomogeneous field distribution with an efficiency Γ lower than 1. In lithium niobate modulators made in x-cut crystals it amounts to approximately 0.65.

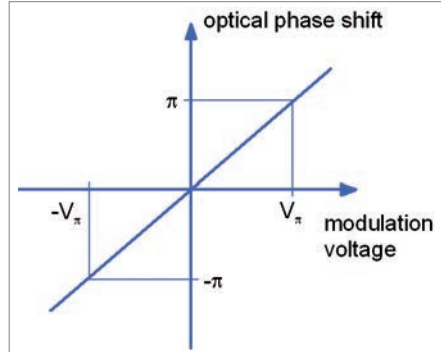

Fig. 1.3 - Phase modulator characteristic curve

The phase shift is linear to the applied voltage (Fig. 1.3). A good approximation of phase shift can be described by:

$$\Delta \varphi = -\frac{\pi L}{\lambda} n_3^3 r_{33} \frac{U}{g} \Gamma$$

The half wave voltage U_{π} , which causes a phase shift of π , is calculated by:

$$U_{\pi} = -\frac{\lambda g}{n_3^3 r_{33} L \Gamma}$$

This typically amounts to a few volts. For longer wavelengths it is higher than for shorter ones at a given electrode geometry. For example it can be expected to be 3 V in the red at 635 nm and 10 V in the telecommunication wavelength range about 1550 nm. Since the maximum applicable voltage is approximately ± 30 V, phase shifts between 20π in the red and 6π at 1550 nm can be reached.

Due to the very fast electrooptic response, together with low control voltages and the use of sophisticated travelling wave electrode geometry, it is possible to achieve modulation at frequencies in the gigahertz range.

Electrooptical modulators

1.4. Amplitude modulators

A phase modulator is inserted into an integrated Mach-Zehnder interferometer to form an amplitude modulator (Fig. 1.4).

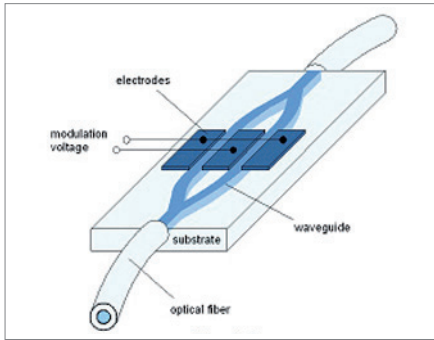

Fig. 1.4 - Mach-Zehnder-amplitude modulator

It is advantageous to place electrodes in push-pull arrangement at both interferometer arms. Applying a voltage leads to a phase difference in both branches, which causes a change of the output power at the device output by means of interference. So the device transmission can be controlled between a minimum and a maximum value (P_{\min} to P_{\max}). A phase difference of π is needed for switching from on to off state or vice versa. The needed voltage is called the half wave voltage V_{π} of the amplitude modulator. Due to the push-pull-operation the half wave voltage of an amplitude modulator is the half of that of a phase modulator with equal electrode length. For example it can be expected to be 1.5 V in the red at 635 nm and 5 V in the telecommunication wavelength range about 1550 nm. The extinction ratio is given by the ratio of maximum to minimum output.

It amounts typically to 500 : 1 in the red and more than 1000 : 1 in the infrared range.

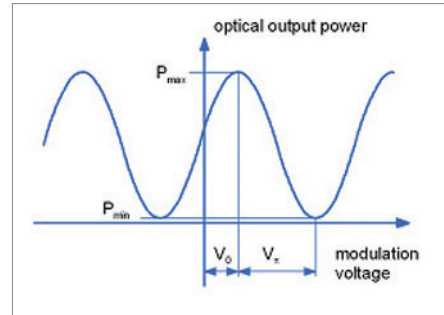

Fig. 1.5 - Amplitude modulator characteristic curve

The output power versus control voltage is periodic (Fig. 1.5) in cosine form:

$$P = P_{\min} + (P_{\max} - P_{\min}) \left(\frac{1}{2} \cos \left(\frac{\pi(U - U_0)}{U_{\pi}} \right) + \frac{1}{2} \right)$$

The operation point differs from the theoretical value $V_0 = 0$. It must be controlled by special electronics.

Applying a rf signal as modulation voltage to the electrodes this electrical input is translated into an amplitude information (Fig. 1.6). This amplitude output depends on the voltage magnitude and shape, thus related to the position of the modulators operation point. The figure depicts the transmission of a binary pulsed electrical input into a binary optical output signal. If the voltage levels would not be correct, that is that the voltage is too high or the offset is not correct the modulator will react with non correct optical output levels in binary operation or with higher harmonics in analog operation.

Selection Criteria

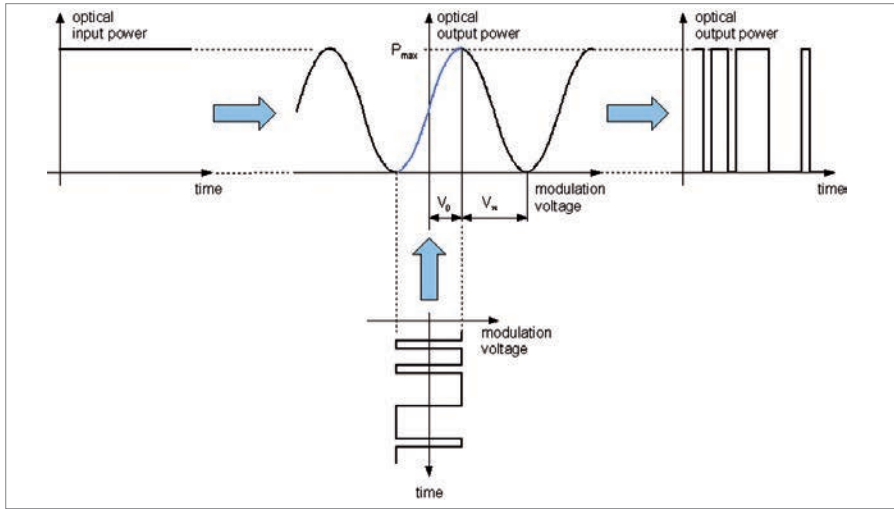

Fig. 1.6 - Mach-Zehnder-amplitude modulator operation

2. Selection Criteria

Integrated-optical modulators made of LiNbO_3 are available for different applications and wavelengths. The selection is done depending upon the desired application.

2.1. Wavelength and wavelength range

Various properties of the modulators, in particular the half wave voltage and insertion loss, depend on the operation wavelength. While the half wave voltage decreases at shorter wavelengths, the insertion loss increases, which is mostly due to Rayleigh scattering and a little due to absorption.

The usable wavelength range (spectral or optical bandwidth) of proper modulator operation is limited by the modal behaviour of the waveguide. It depends on the substrate material and the central wavelength. The singlemode operation

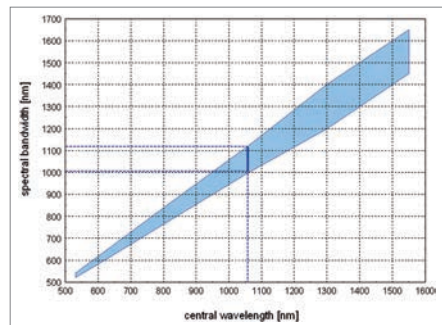

Fig. 2.1 - Usable wavelength range

and definite modulation is guaranteed within this range.

For a given central wavelength for which the modulator was fabricated the modulator can accept laser wavelengths out of a range which is coloured in the figure 2.1. For example at 1060 nm central wavelength the optical bandwidth is ± 60 nm, i.e. the modulator can ope-

Selection Criteria

rate between 1000 nm and 1120 nm. At longer wavelength the insertion loss increases due to waveguide cut-off and at shorter wavelengths the modulation is nondefinite due to interference of higher oscillation modes, respectively, leading to contrast loss in amplitude modulators or residual amplitude modulation in phase modulators.

2.2. Fibre pigtail and polarisation of light

Linear polarised light is required for definite modulator operation. Since the used waveguide type in lithium niobate is polarising, transmission losses are caused if the input polarisation is not linear or not sufficiently adjusted.

The modulators are produced with fibre pigtails with the standard length of 1 m. Other lengths are possible on request. At the input port a polarisation maintaining fibre is required. The output fibre is also polarisation maintaining, but standard singlemode (non-PM) fibres are available on request too.

The polarisation in the fibre is aligned to the stress rods in slow axis direction usually. Bow-tie fibres are used as standard. Panda fibres can be provided on request. To prevent back-reflection into the input

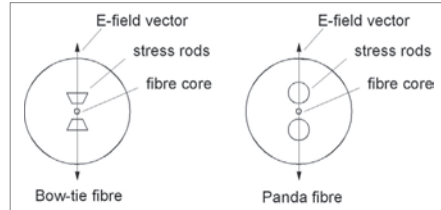

Fig. 2.2 - Polarisation maintaining fibres in Bow-tie and Panda style

fibre the optical faces between fibre and modulator crystal are angled.

The devices can be delivered with bare fibre ends or fibre connectors, preferably FC/PC- or FC/APC-connectors with 8° angled polished surface. The polarisation is aligned to the connector key as depicted in the figure 2.3. Other connectors or other polarisation alignment can be provided on request.

2.3. Optical power cw operation

The transmittable optical power depends on the wavelength. For wavelengths of more than 1 μm an optical power up to 0.5 W at the device input can be used. In the red range it amounts to 30 mW and 10 mW in the green.

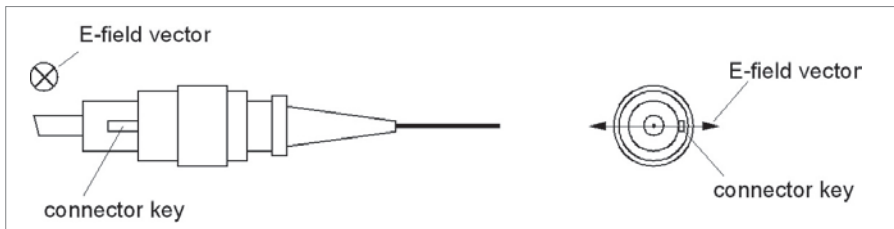

Fig. 2.3 - Alignment of polarization in FC-connectors

Selection Criteria

pulsed operation

The transmittable optical power depends on the wavelength, the pulse width, the repetition rate and the average power. The behavior is not known for every conceivable application. For example the modulators are able to operate with 150 fs pulses, 1060 nm at a repetition rate of about 80 MHz at an average power of app. 50 mW in the input fibre. In the fibre the pulse length and pulse spectrum are spread up due to the non-linear fiber dispersion.

2.4. Spectral width of light

The modulators are designed for operation at one narrowband wavelength since the half wave voltage depends on the wavelength. An increase of the spectral width leads to lower extinction ratio of amplitude modulators due to the interference operation principle. While near the zero order the extinction is sufficient for most cases it decreases drastically to higher orders of interference. This is also valid for pulsed operation.

The figure 2.4 shows the operation curve

with some orders of interference at 1060 nm for cw operation and pulsed operation. 150 fs pulses with a spectral width of 8 nm FWHM were fed into the input fibre. While fibre transmission the pulses spread up to 3 ps, 30 nm FWHM. This happened in the first centimeters of the fibre, the modulator did not influence the spectrum any more. In the lowest order the extinction was about 1000 : 1, then 100 : 1, then 30 : 1 and so on.

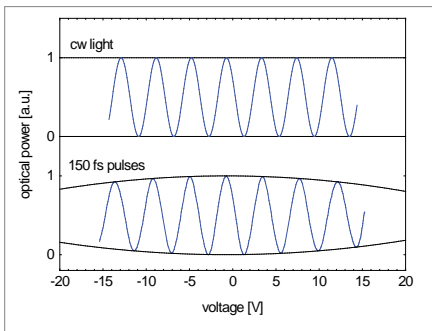

Fig. 2.4 - modulation characteristic for cw and femtosecond-pulsed light input

Technical data

3. Technical data

The modulators are available for a variety of wavelengths. In principle modulators for every wavelength between 532 nm and 1550 nm can be provided if a laser

whose wavelength is near to the desired wavelength is available. The modulator data of some standard wavelengths are depicted in the following:

Size and measures

Amplitude modulators

Type	AM 532	AM 635	AM 830	AM 1064	AM 1550
Wavelength*)	532 nm	635 nm	830 nm	1064 nm	1550 nm
Spectral bandwidth	±10 nm	±20 nm	±40 nm	±60 nm	±100 nm
Insertion Loss, typical	7 dB	7 dB	6 dB	5 dB	5 dB
Extinction, typical	200 : 1	500 : 1	800 : 1	1000 : 1	1000 : 1
Minimum optical rise time 10/90, typical	1 ns	200 ps	200 ps	200 ps	200 ps
Optical Connection, input	Standard Fibre connector		Polarisation maintaining single mode fibre Bare fibre, FC/PC or FC/APC connector		
Optical Connection, output	Standard		Polarisation maintaining single mode fibre		
	Optional		Single mode or multi mode fibre		
	Fibre connector		Bare fibre, FC/PC or FC/APC connector		
Half wave voltage, typical	2 V	3 V	3 V	3 V	5 V
Maximum optical input power (cw)	10 mW	30 mW	50 mW	300 mW	300 mW

Phase modulators

Typ	PM 532	PM 635	PM 830	PM 1064	PM 1550
Wavelength*)	532 nm	635 nm	830 nm	1064 nm	1550 nm
Spectral bandwidth	±15 nm	±20 nm	±40 nm	±60 nm	±100 nm
Insertion Loss, typical	7 dB	6 dB	5 dB	4 dB	3 dB
Minimum optical rise time 10/90, typical	1 ns	200 ps	200 ps	200 ps	200 ps
Optical Connection, input	Standard		Polarisation maintaining single mode fibre		
	Fibre connector		Bare fibre, FC/PC or FC/APC connector		
Optical Connection, output	Standard		Polarisation maintaining single mode fibre		
	Optional		Single mode or multi mode fibre		
	Fibre connector		Bare fibre, FC/PC or FC/APC connector		
Half wave voltage, typical	4 V	6 V	6 V	6 V	10 V
Maximum optical input power (cw)	10 mW	30 mW	50 mW	300 mW	300 mW

*) Other wavelengths on request

Technical data

The modulators are available in standard cases. Their measures are sketched as follows:

4. Electrical control of the modulators

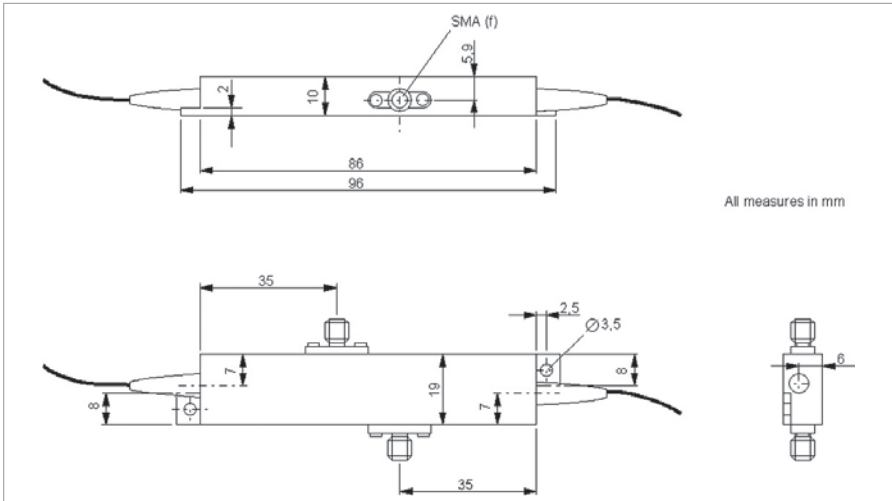

Fig. 3.1 - Standard phase and amplitude modulator case

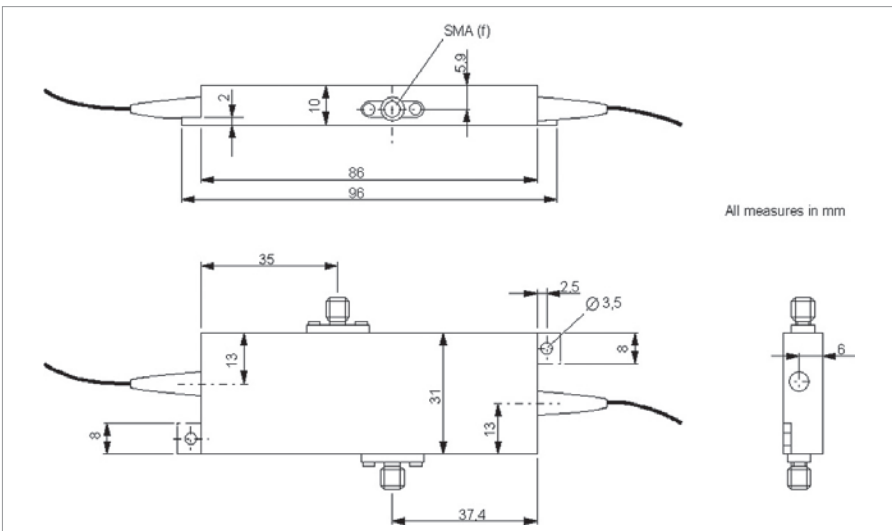

Fig. 3.2 - Widened amplitude modulator case with separated bias output

Electrical control of the modulators

4.1. Internal wiring of the modulator

1. Standard phase and amplitude modulator wiring scheme

All phase modulators and the standard amplitude modulators are available

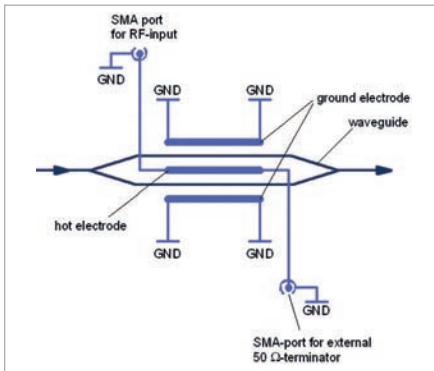
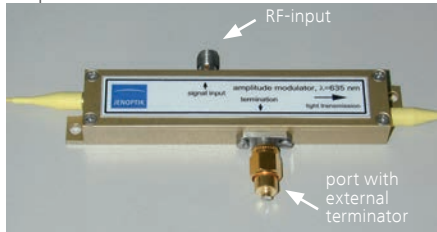

Fig. 4.1 - Standard wiring scheme

without electronics inside the modulator case (Fig. 4.1). Both ends of the hot electrode on the modulator crystal are connected to SMA connectors. The ground electrodes are connected to the modulator case as well as the ground of the SMA connectors. One SMA connector can be used as RF input, at the second connector a 50 Ω terminator is recommended to avoid reflections of the RF signal which may disturb the modulation and the control electronics. The input modulator impedance is 50 Ω , the ohmic resistance

between both ports between 5 and 10 Ω except at the modulators for green light, where it is roughly 150 Ω . The capacity amounts to app. 20 pF. The terminator can be removed for measuring purposes or to connect the modulator with further electronics. The modulator is electrically and optically symmetric. At higher modulation speed (500 MHz or more) the optical transmission direction must be the same as the electrical transmission direction.

If a short rise time electrical input signal is applied the minimum optical rise time is app. 200 ps, except for the green light modulators, where it is 1 ns. A bias, which is necessary to control the operation point, causes a current through the hot electrode which may heat the electrode and the terminator. This can be prevented using a wiring scheme which is described in the further chapters.

2. Wiring scheme inside the amplitude modulator with separate RF and bias inputs

To separate the RF- and the bias-inputs a wiring scheme like depicted in Fig. 4.2 can be integrated into the modulator case. All modulator electrodes are electrically isolated from the modulator case. The hot electrode is terminated internally, while the ground electrodes are connected to the ground by use of capacitors which cause a RF connection, but a bias separation. So the bias can be fed by a second connector up to a frequency at which the capacitors become transparent. This is approximately 10 kHz with 100 nF capacitors and approximately 100 kHz if 10 nF capacitors are used.

Electrical control of the modulators

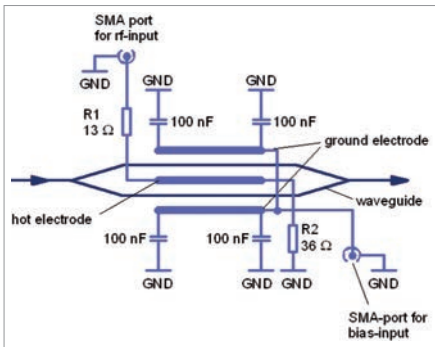
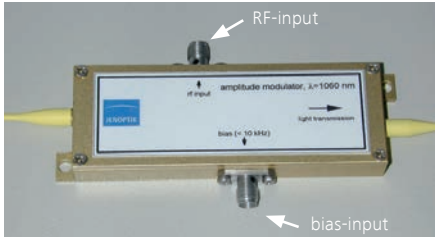

Fig. 4.2 - Wiring scheme with separated bias

If a short rise time electrical input signal is applied the minimum optical rise time is app. 500 ps, except for the green light modulators, where it is 1 ns. The bias does not cause a current through the hot electrode. The bias caused current is due

to the capacitive resistance, thus frequency dependent. At DC the bias caused current is zero.

3. Separation of RF and bias using an amplitude modulator with standard modulator wiring scheme

The described bias scheme can be built up externally if a modulator with standard wiring scheme is used. Here the modulator case must be placed isolated and be connected to the ground using capacitors (Fig. 4.3). It is useful to place the modulator case and the surrounding circuit in a RF-sealed case. If the lengths of the wires are short enough the electrical and optical properties are identical to the integrated version which was described in the previous chapter. The advantage is that the modulator can be removed from the outer case and be used as a standard one.

4.2. Driving of the modulator

For modulator driving no special driver is required. Any voltage supply with a controllable output voltage amplitude of 6 - 10 V (connected to 50 Ω) depending

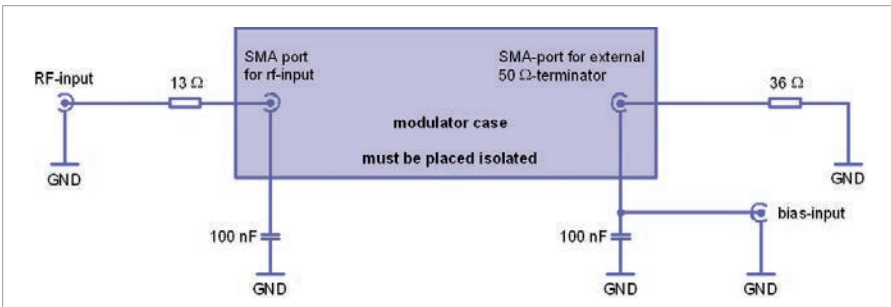

Fig. 4.3 - External wiring scheme for bias separation

Electrical control of the modulators

on the modulator type, with a controllable offset and which is fast enough is suitable for modulator driving. If the supply output voltage is not sufficient an additional voltage amplifier may be necessary.

Adjustment of modulator operation:

The modulator can be used for analog and digital modulation. Every voltage source can be used for modulator driving if its electrical output amounts to some volts connected to $50\ \Omega$ and which is fast enough. The voltage which is applied to the modulator should not exceed 30 V. For analog modulation the periodical characteristic curve must be taken into account.

For digital modulation a fast pulse generator can be used. Its upper and lower voltage level (i.e. amplitude and offset) must be adjustable independently. Then the modulator can be driven in two modes – the pulsed mode for short optical pulse generation and the switching mode for modulator switching.

The explanation will be done using a modulator with $V_{\pi} = 2\ \text{V}$ and $V_0 = 1,5\ \text{V}$.

Pulsed mode:

The modulator is switched between two voltage levels for which the optical output power is zero (in the figure -0.5 and 3.5 V). The modulator is switched from the off-state via the on-state to the next off-state (blue line and blue arrows in Fig. 4.4). It transmits a light pulse during the switching process. The optical pulse length corresponds to the rise time of the

input voltage (1 ns in Fig. 4.5).
Switching mode:

The modulator is switched between two

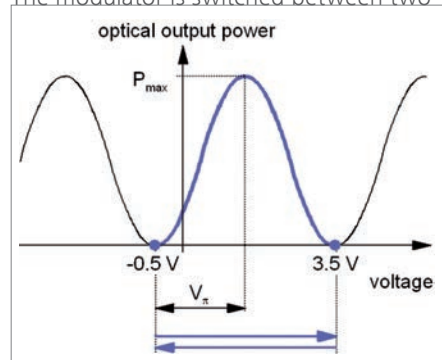

Fig. 4.4 - Pulsed mode

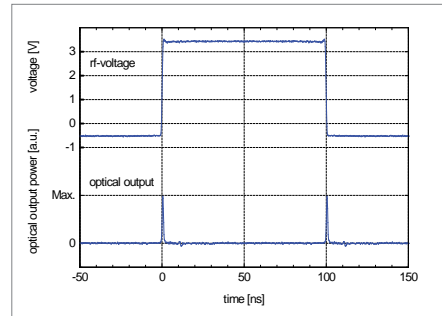

Fig. 4.5 - Generation of 1 ns pulses

voltage levels, for one the optical output is zero and for the other the optical output is maximum (in the figure -0.5 and 1.5 V). The modulator is switched from the off-state to the next on-state (blue line and blue arrows in Fig. 4.6). It will be switched on or switched off vice versa. The optical rise time corresponds to the rise time of the input voltage. If a light pulse should be generated its length

Electrical control of the modulators

corresponds to the time between on-switching and off-switching (100 ns in Fig. 4.7).

4.3. Determination of V_0 and V_π

The parameters V_0 and V_π of the cha-

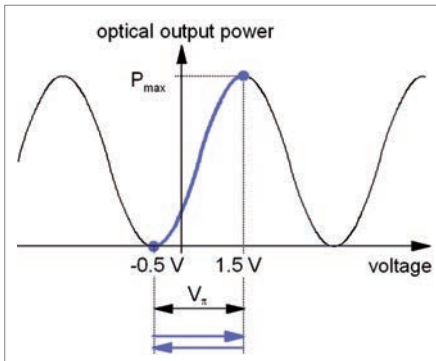

Fig. 4.6 - Switching mode

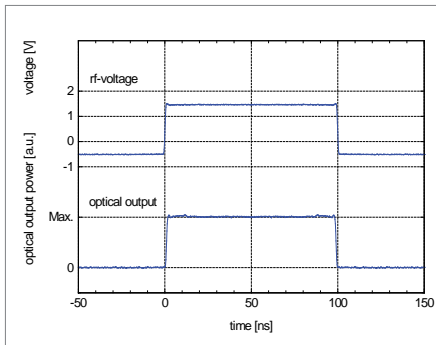

Fig. 4.7 - Generation of 1 ns edges

racteristic curve can be determined as follows:

A laser or laser diode is coupled to the modulator input fibre. The modulator output fibre sends its light into a photo-diode. The electrical modulator input is

Electrical control of the modulators

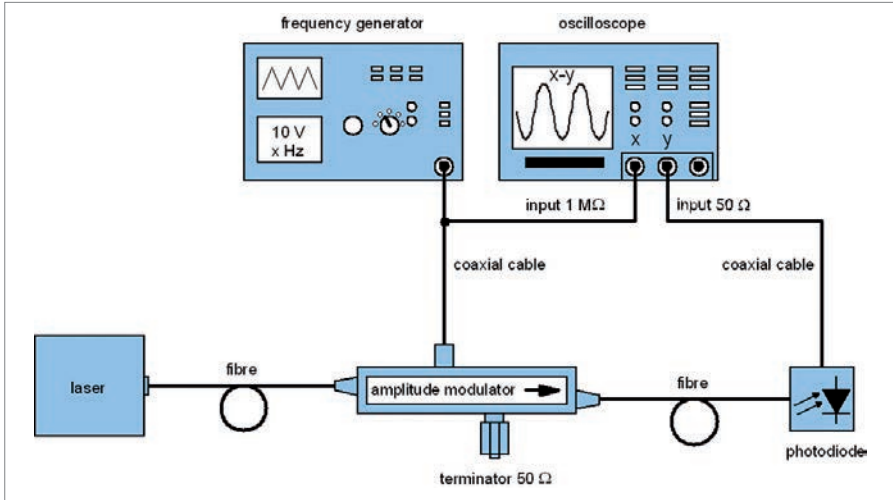

Fig. 4.8 - Setup for operation curve measurement

connected to a frequency generator and a high ohmic oscilloscope x-input using

a computer and to do a cosine fit then (Fig. 4.8).

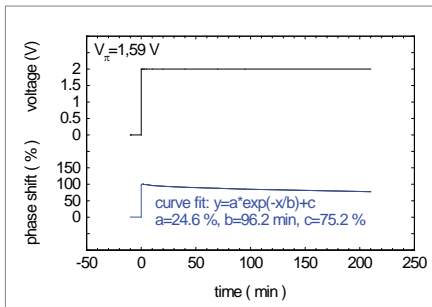

Fig. 4.9 DC drift: phase back-drift while DC voltage is applied measured at an amplitude modulator

coaxial cables. The photodiode is connected to the 50 Ω oscilloscope y-input. The x-y- plot shows the characteristic curve, where V_{π} and V_0 can be determined. It is useful to save the curve data using

4.4. DC behaviour of lithium niobate modulators

Waveguide modulators made of lithium niobate react on DC voltage with the so-called DC drift (Fig. 4.9). After applying a DC voltage a charge transport in the crystal takes place. That's why the electric field which is applied to the electrodes is compensated partially, so that the effective electric field decreases partially with time. This process is related with the number of free charge carriers and with the dark- and photoconductivity of the crystal, respectively. Since the dark conductivity depends on the temperature and the crystal purity, while the photoconductivity depends on the crystal purity

Electrical control of the modulators

ty, wavelength and optical power density (i.e. the optical power in the waveguide), the duration of the compensation process depends on these values. It takes some minutes to some hours. The duration will become shorter the higher the temperature and optical power density and the shorter the wavelength. The compensation saturates at approx. 75 % of the initial value. The compensation time does not depend on the initial voltage. That means that the amount of the drift per time (i.e. the first derivate of the curve where the phase is plotted against time) becomes faster at higher DC voltages.

This partial compensation process of the electric field which passes the waveguide causes a partial back-drift of the initial optical phase shift which was caused by the applied voltage. At phase modulators it can be measured directly by use of an interferometer. In the case of amplitude modulators the optical phase shift is followed by an amplitude modulation of the optical output due to its cosine characteristic curve. This can be measured as shift of V_0 . V_π does not change its value.

The diagram (Fig. 4.9) shows an example of the phase drift which was measured at a 1550 nm amplitude modulator with an optical power of some milliwatts at room temperature. The phase is given in % of the initial value and was calculated by use of the cosine characteristic curve of the modulator. The applied voltage (2 V)

was a little higher than V_π (1.59 V), that means that the initial phase has been 1.25π . It is to be seen that the time which is needed for stabilisation is more than

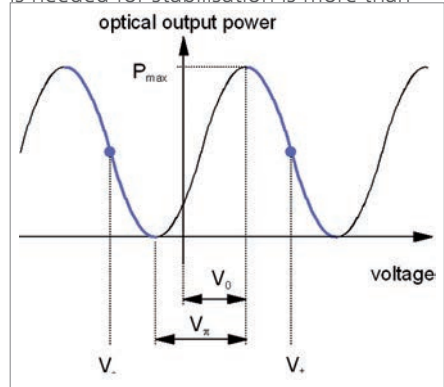

Fig. 4.10 - modulator characteristic curve with two equivalent operation points

one hour if the modulator is used in the infrared at moderate optical power. The drift will be faster if higher optical power or shorter wavelengths are used, but the modulator reacts more on changes of the light and environmental conditions also.

A stabilisation of the operation point can be done as follows:

1. dynamic mode:

Due to the periodicity of the output signal it is possible to modulate at different parts of the characteristic curve, which are differing by a multiple of $2 \cdot V_\pi$. The operation point should jump between two equivalent voltage values with alternating sign, in the sketch depicted as

$$A_- = \int_{V_-} U(t) dt$$

V_- and V_+ . Then the modulation occurs

Electrical control of the modulators

alternating on both blue sketched parts of the characteristic.

To avoid DC-drift the applied voltage V

$$A_+ = \int_{U_-} U(t) dt$$

should be measured and integrated for

$$|A_+| = |A_-|$$

a time which is short enough against the duration of the DC drift (< 1 second) while the modulator operates at the operation point V_- .

The value A_- with:

will be reached in this time.

After this the operation point has to switch to V_+ where the modulator operates until the value A_+ with is reached, where must be fulfilled.

Then the operation point has to switch to V_- again and so on. This causes that the average value of the applied voltage is zero and no DC-drift can occur. It must be taken into account that the modulator passes the periodic characteristic while changing between V_- and V_+ which produces an unwanted optical power modulation.

2. Bias mode

The operation point must be set using a bias. The bias can be applied using a bias-T in front of the RF input of the modulator, which adds a DC or low frequency bias to the RF signal. But this causes an electrical current through the modulator electrodes and the terminator which is a load for the voltage source and

causes a heating of the electrodes and the terminator.

The better way is to use an external bias scheme or an integrated bias circuit like depicted in the previous chapter. But the bias mode cannot avoid the DC drift.

If the modulation is periodic the average of the applied voltage is constant. Furthermore, if the temperature as well the optical power will not be changed, the drift will saturate after a certain time and a stable operation regime can be reached by correcting the bias voltage.

In the case of nonperiodic modulation or changing environmental conditions a feed back loop must be used. A part of the optical modulator output must be split up using a fibre coupler or a partial mirror and fed into a photodiode. The type of the correction electronics depends on the modulation. No recipe can be given here which fulfils all thinkable demands. For example if short optical pulses with relative long delays have to be generated or pulses have to be picked it is sufficient to hold the bias on the voltage which causes a minimum average output power since the integrated underground signal is a considerable larger part of the average power than the pulse power itself. If an analogue modulation is necessary the actual output signal must be measured and be compared with the

Application examples

desired output signal. In some cases, for example in image generation, it is possible to measure the characteristic curve automatically in a time where the modulator output is not needed. The amount of the bias voltage should not be too large since the slope of the phase shift curve becomes steeper at higher biases and the correction must be done in shorter times.

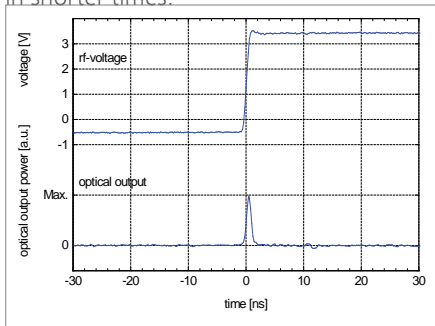

Fig. 5.1 - Generation of a 1 ns pulse

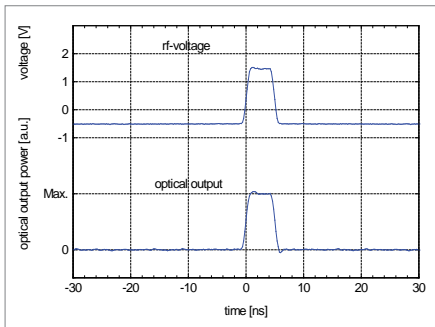

Fig. 5.2 - Generation of a 5 ns pulse

5. Application examples

5.1. Pulse slicing

One essential modulator application is to generate and to shape short pulses using cw laser light. The advantage is that the

pulse shape can be controlled independently on the laser type. This is needed in some laser applications, especially in fibre oscillator-amplifier arrangements.

For example a short light pulse is ge-

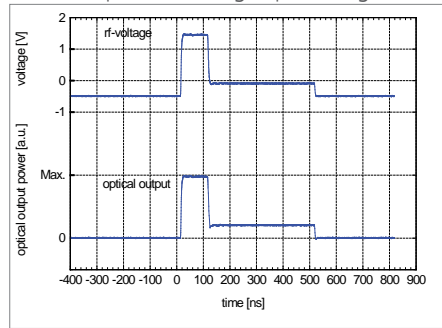

Fig. 5.3 - Generation of a two-step pulse

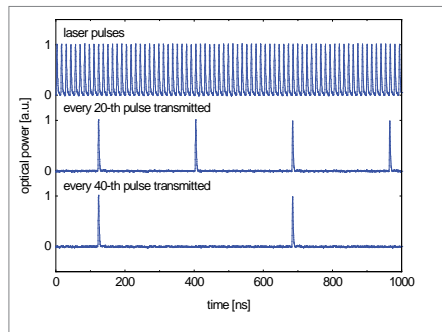

Fig. 5.4 - pulse picking

nerated if an electrical edge with the amplitude $2xV_{\pi}$ or an electrical pulse of the amplitude V_{π} is applied (Fig. 5.1 and 5.2). An analog temporal shaping of light pulses can be done in similar manner, like it is depicted using a two-step pulse (Fig. 5.3). Furthermore it is possible to shorten or to shape long laser pulses for example from the microsecond into the nanosecond range.

Application examples

5.2. Pulse picking

Single pulses or pulse combs can be selected from fast laser pulse chains. Thus

the amplitude modulator operates as pulse picker to reduce the repetition rate of the laser.

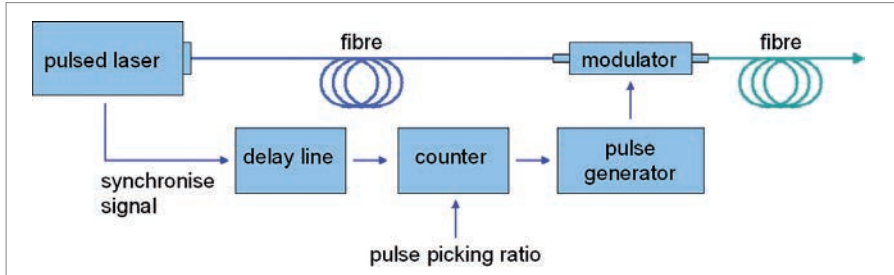

Fig. 5.5 -Scheme of pulse picker setup

The following examples explain the pulse picking from a 1060 nm, 150 fs, 76 MHz pulse chain. The figures show low pulse reduction ratios for better visibility, i.e. with the ratios of 20 and 40 in Fig. 5.4. In most cases picking by a factor between 100 and 1000 is necessary. The operation principle acts as follows (Fig. 5.5): A pulsed laser sends its light into an amplitude modulator which is in the off-state. An electrical or optical synchronise signal

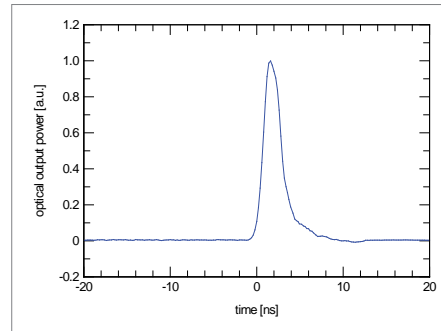

Fig. 5.7 - Temporal modulator transmission

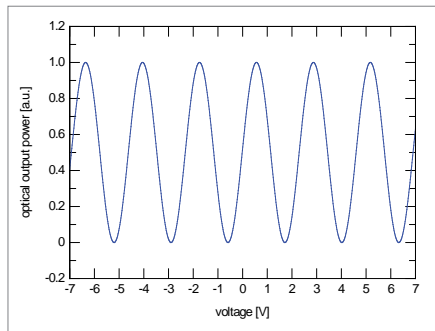

Fig. 5.6 - Modulator characteristic curve

which is taken from the pulsed laser too feeds an electrical delay line. This is used to equalise the runtimes of the pulses in the fibre and wires and the driver operation time. A counter counts the synchronise signal pulses up to a preset number. Then the counter sends a pulse to a pulse generator which drives the modulator thus opening it for the transmission of one or a number of light pulses. The modulator will be driven according to the pulsed mode, that is the modulator is

Application examples

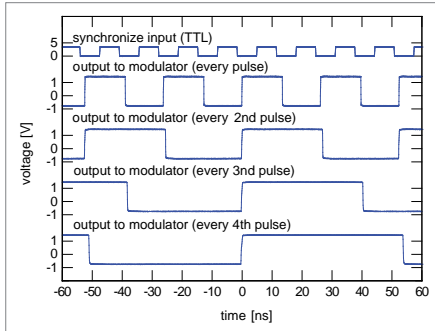

Fig. 5.8 - Temporal output voltages to the modulator

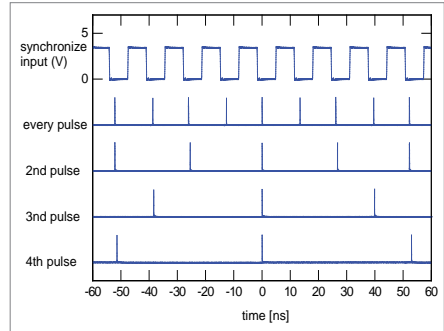

Fig. 5.9 - Temporal modulator transmission

switched between two neighbored off-states using an electrical edge of $2 \times V_{\pi}$, that is between -0.7 V and 1.7 V where the half wave voltage amounts to 1.2 V (Fig. 5.6). The rise time must be shorter than given by the repetition rate of the laser. In the example it amounts to app.

Description of terms

3 ns (Fig. 5.7).

Insertion loss (D)	<p>Loss of optical power if light is transmitted through the modulator</p> $D = 10 \lg (P_{in}/P_{out})$ <p>P_{in}: optical power which is guided in the input fibre P_{out}: optical power which is guided in the output fibre if modulator transmission is maximum (on-state) (measurement using fibre cut back method)</p>
Extinction (E) (contrast ratio)	<p>In the case of amplitude modulator the ratio of transmitted optical power in on- and off-states</p> $E = P_{max}/P_{min}$ <p>(measurement at DC-voltage)</p>
Half wave voltage (V_{π})	<ul style="list-style-type: none"> - In the case of amplitude modulator the voltage difference for switching the modulator from on- to off-state or vice versa - In the case of phase modulator the voltage difference for shifting the phase of the optical output signal by π
Offset (V_0)	<p>Lowest voltage compared to 0 V, at which the transmission of an amplitude modulator is maximum (on-state)</p>
Polarisation of output fibre	<p>Polarisation ratio of the light in the output fibre if a polarisation maintaining fibre is used</p>
Spectral bandwidth	<p>Possible deviation of a narrow band operation wavelength from the central wavelength of the modulator without substantial diminution of extinction and insertion loss (increase of insertion loss or decrease of extinction by 10 % with respect to the central wavelength)</p>
Upper critical frequency	<p>Frequency at which the effect of the electrical input on the optical output signal decreases by one half</p>
Minimum optical rise time	<p>Time in which the optical signal of an amplitude modulator rises or falls between the 10 % and 90 % values of maximal transmission if an exact electrical step-function is applied to switch the modulator between on- and off-states</p>

Notice

Notice



JENOPTIK | Healthcare & Industry

Healthcare Business Unit

JENOPTIK Optical Systems GmbH

Goeschwitzer Strasse 25

07745 Jena | Germany

Phone +49 3641 65-4530 | Fax -3807

lightmodulators@jenoptik.com

www.jenoptik.com/light-modulators